

### Features

- Pressure Rating up to 6,000 psig (413 bar) @ 100°F (38 °C).
- Temperature Rating up to 449°F (232°C) with standard PTFE packing; up to 1,200°F (648°C) with Grafoil packing.
- Standard 316 stainless steel, optional Alloy 400, and Alloy C276 construction.
- Valve stem back seating against the bevelled edge of bonnet in fully open position prevents maximum leakage through bonnet when packing fails.
- Standard non-rotating stem disc and stem packing below the threads design.

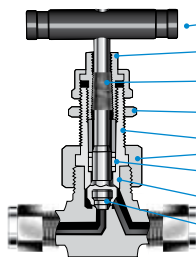

- **Handle**- Standard SS316 bar handle, optional aluminum bar handle.
- **External Packing Bolt**- allows packing adjustment without the valve disassembly.
- **Roll threaded and hard chrome plated stem**- is for long valve life.
- **Panel Mounting Nut**- is standard and permits valve to panel or actuator.
- **Union Nut**- prevents accidental disassembly of the valve in service.
- **Stem Packing below the threads**- prevents media contamination and thread lubricant washout.
- **Stem Back Seating**- in fully open position.
- **Non-Rotating Stem Disc at Closure**- is for maximum metal seat life and positive seal.

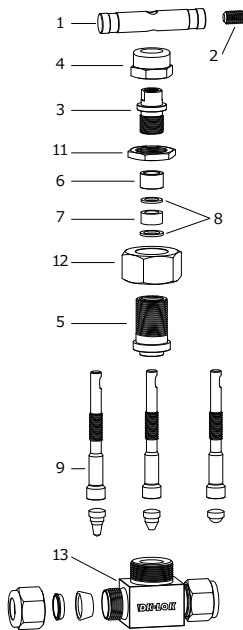

### Materials of Construction

Component	Valve Body Materials		
	SS316	Alloy 400	Alloy C276
	<b>Material Grade/ASTM Specification</b>		
1. Bar handle	SS316/A276, optional anodized aluminum handle		
2. Set screw	SS304, Grade B8/A193		
3. Packing bolt	SS316/A276 or A479		
4. Cap nut	SS316/A276 or A479		
5. Bonnet	SS316/A276 or A479	Alloy 400/B164	C276/B574
6. Gland	SS316/A276 or A479	Alloy 400/B164	C276/B574
7. Packing (2)	PTFE/D1710, optional PEEK & Grafoil		
8. Packing supports (2)	SS316/A276 or A479	Alloy 400/B164	C276/B574
9. Stem	Hard Chrome-plated SS316/A276 or A479	Alloy 400/B164	C276/B574
10. Standard globe disc, optional globe ball & regulating disc.	TYPE630/A564	Alloy 400/B164	C276/B574
11. Panel nut	SS316/A276 or A479		
12. Union nut	SS316/A276 or A479		
13. Body	SS316/A276 or A479	Alloy 400/B164	C276/B574

Wetted parts and lubricants are listed in blue.

#### Lubrication :

- Nickel anti-seize lubricant (hydrocarbon carrier).
- Ball disc: hydrocarbon-based.

### Technical Data

Ratings below are for valves with standard PTFE packing. Refer to valve ratings with optional packing on Page 3.

Valve Material	Stem Disc Designator	Temperature Rating °F(°C)	Pressure Rating @ -65 to 100°F (-53 to 38°C)
SS316 Alloy 400 Alloy C276	Globe: Nil. Regulating: -R Ball: -B	-65 to 450 (-53 to 232)	6,000 psig (413 bar)

Globe Disc

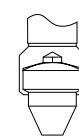

Ball Disc

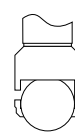

Regulating Disc

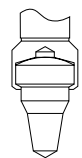

### Factory Test and Cleaning

Every valve is tested with the nitrogen gas @ 1,000 psig (68.9 bar) for leakage at the seat to a maximum allowable leak rate of 0.1 SCCM. The packing is tested for no detectable leakage. Optional hydrostatic shell test with additional cost is performed with pure water at 1.5 times the working pressure. Every valve is cleaned and packaged in accordance with DK-Lok cleaning standard DC-01.

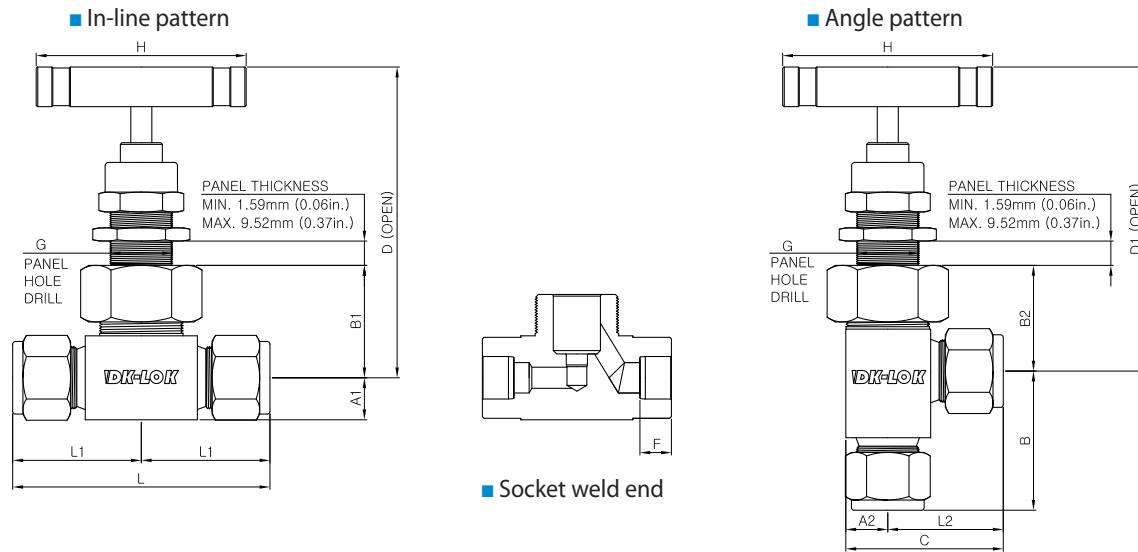

Basic Ordering Number	End connections		Orifice mm (in.)	Cv	Dimensions, mm (inch)													
	Inlet	Outlet			L	L1	L2	B	C	B1	B2	A1	A2	H	G	D	D1	F
V16A-	F2N-	1/8 Female NPT	4.0 (0.156)	0.35	50.8(2.00)	25.4(1.00)	22.6(0.89)	25.4(1.00)	32.3(1.27)	27.7(1.09)	27.7(1.09)	9.7(0.38)	9.7(0.38)	44.4(1.75)	15.1(19/32)	77.2(3.04)	77.2(3.04)	-
	F4N-	1/4 Female NPT			52.3(2.06)	26.2(1.03)	22.6(0.89)	25.4(1.00)	32.3(1.27)	27.7(1.09)	27.7(1.09)	9.7(0.39)	9.7(0.38)	44.4(1.75)	15.1(19/32)	77.2(3.04)	77.2(3.04)	-
	M4N-	1/4 Male NPT			50.8(2.00)	25.4(1.00)	25.4(1.00)	25.4(1.00)	35.1(1.38)	27.7(1.09)	27.7(1.09)	9.7(0.38)	9.7(0.38)	44.4(1.75)	15.1(19/32)	77.2(3.04)	77.2(3.04)	-
	MF4N-	1/4 Male to Female NPT			51.6(2.03)	26.2(1.03)	22.6(0.89)	25.4(1.00)	32.3(1.27)	27.7(1.09)	27.7(1.09)	9.7(0.39)	9.7(0.38)	44.4(1.75)	15.1(19/32)	77.2(3.04)	77.2(3.04)	-
	D6M-	6mm DK-Lok			61.0(2.40)	30.5(1.20)	29.5(1.16)	37.6(1.48)	39.1(1.54)	27.7(1.09)	27.7(1.09)	9.7(0.38)	9.7(0.38)	44.4(1.75)	15.1(19/32)	77.2(3.04)	77.2(3.04)	-
	D4T-	1/4 DK-Lok			61.0(2.40)	30.5(1.20)	29.5(1.16)	37.6(1.48)	39.1(1.54)	27.7(1.09)	27.7(1.09)	9.7(0.38)	9.7(0.38)	44.4(1.75)	15.1(19/32)	77.2(3.04)	77.2(3.04)	-
	SW4T-	1/4 TSW			46.2(1.82)	23.1(0.91)	22.4(0.88)	30.2(1.19)	31.8(1.25)	27.7(1.09)	27.7(1.09)	9.7(0.38)	9.7(0.38)	44.4(1.75)	15.1(19/32)	77.2(3.04)	77.2(3.04)	7.1(0.28)
	D8M-	8 mm DK-Lok			61.0(2.40)	30.5(1.20)	-	-	-	27.7(1.09)	-	9.7(0.38)	-	44.4(1.75)	15.1(19/32)	77.2(3.04)	-	-
V16B-	F4N-	1/4 Female NPT	6.4 (0.25)	0.86	57.2(2.25)	28.4(1.12)	25.4(1.00)	28.4(1.12)	38.1(1.50)	34.0(1.34)	37.3(1.47)	12.7(0.50)	12.7(0.50)	63.5(2.50)	19.8(25/32)	92(3.62)	92(3.62)	-
	F6N-	3/8 Female NPT			57.2(2.25)	28.4(1.12)	25.4(1.00)	28.4(1.12)	38.1(1.50)	34.0(1.34)	37.3(1.47)	12.7(0.50)	12.7(0.50)	63.5(2.50)	19.8(25/32)	92(3.62)	92(3.62)	-
	D10M-	10mm DK-Lok			72.4(2.85)	36.1(1.42)	33.0(1.30)	39.4(1.55)	45.7(1.80)	34.0(1.34)	34.3(1.35)	12.7(0.50)	12.7(0.50)	63.5(2.50)	19.8(25/32)	92(3.62)	92(3.62)	-
	D6T-	3/8 DK-Lok			71.9(2.83)	35.8(1.41)	32.8(1.29)	42.2(1.66)	45.5(1.79)	34.0(1.34)	31.0(1.22)	12.7(0.50)	12.7(0.50)	63.5(2.50)	19.8(25/32)	92(3.62)	92(3.62)	-
	D12M-	12mm DK-Lok			77.2(3.04)	38.6(1.52)	35.6(1.40)	41.9(1.65)	48.3(1.90)	34.0(1.34)	34.0(1.34)	12.7(0.50)	12.7(0.50)	63.5(2.50)	19.8(25/32)	92(3.62)	92(3.62)	-
	D8T-	1/2 DK-Lok			77.2(3.04)	38.6(1.52)	35.6(1.40)	41.9(1.65)	48.3(1.90)	34.0(1.34)	34.0(1.34)	12.7(0.50)	12.7(0.50)	63.5(2.50)	19.8(25/32)	92(3.62)	92(3.62)	-
	SW4P-	1/4 PSW			57.2(2.25)	28.4(1.12)	25.4(1.00)	28.4(1.12)	38.1(1.50)	34.0(1.34)	37.3(1.47)	12.7(0.50)	12.7(0.50)	63.5(2.50)	19.8(25/32)	92(3.62)	92(3.62)	9.5(0.37)
	SW6T-	3/8 TSW			57.2(2.25)	28.4(1.12)	25.4(1.00)	31.8(1.25)	38.1(1.50)	34.0(1.34)	34.0(1.34)	12.7(0.50)	12.7(0.50)	63.5(2.50)	19.8(25/32)	92(3.62)	92(3.62)	7.9(0.31)
SW8T-	1/2 TSW	57.2(2.25)	28.4(1.12)	25.4(1.00)	25.4(1.00)	38.1(1.50)	34.0(1.34)	35.6(1.40)	12.7(0.50)	12.7(0.50)	63.5(2.50)	19.8(25/32)	92(3.62)	92(3.62)	9.5(0.37)			
V16C-	F8N-	1/2 Female NPT	11.1 (0.437)	2.20	79.2(3.12)	39.6(1.56)	33.3(1.31)	39.6(1.56)	50.8(2.00)	46.2(1.82)	50.8(2.00)	15.7(0.62)	17.5(0.69)	88.9(3.50)	26.2(1-1/32)	121(4.78)	126(4.97)	-
	F12N-	3/4 Female NPT			82.6(3.25)	41.1(1.62)	-	-	-	48.5(1.91)	-	19.8(0.78)	-	88.9(3.50)	26.2(1-1/32)	124(4.88)	-	-
	F16N-	1" Female NPT			91.9(3.62)	46.0(1.81)	-	-	-	54.1(2.13)	-	25.4(1.00)	-	88.9(3.50)	26.2(1-1/32)	129(5.10)	-	-
	MF8N-	1/2 Male to Female NPT			79.2(3.12)	39.6(1.56)	33.3(1.31)	39.6(1.56)	50.8(2.00)	46.2(1.82)	50.8(2.00)	15.7(0.62)	17.5(0.69)	88.9(3.50)	26.2(1-1/32)	121(4.78)	126(4.97)	-
	MF12N-	3/4 Male to Female NPT			82.6(3.25)	41.1(1.62)	36.5(1.43)	41.3(1.62)	56.4(2.22)	48.5(1.91)	50.8(2.0)	19.8(0.78)	19.8(0.78)	88.9(3.50)	26.2(1-1/32)	124(4.88)	126(4.97)	-
	MF16N-	1" Male to Female NPT			91.9(3.62)	46.0(1.81)	-	-	-	54.1(2.13)	-	25.4(1.00)	-	88.9(3.50)	26.2(1-1/32)	129(5.10)	-	-
	D12M-	DK-Lok 12mm			99.6(3.92)	49.8(1.96)	42.7(1.68)	52.8(2.08)	60.2(2.37)	46.2(1.82)	47.8(1.88)	15.7(0.62)	17.5(0.69)	88.9(3.50)	26.2(1-1/32)	121(4.78)	123(4.85)	-
	D8T-	1/2 DK-Lok			99.6(3.92)	49.8(1.96)	42.7(1.68)	52.8(2.08)	60.2(2.37)	46.2(1.82)	47.8(1.88)	15.7(0.62)	17.5(0.69)	88.9(3.50)	26.2(1-1/32)	121(4.78)	123(4.85)	-
	D12T-	3/4 DK-Lok			99.0(3.89)	49.5(1.94)	42.7(1.68)	52.8(2.08)	60.2(2.37)	46.2(1.82)	47.8(1.88)	15.7(0.62)	17.5(0.69)	88.9(3.50)	26.2(1-1/32)	121(4.78)	123(4.85)	-
	D16T-	1 DK-Lok			104(4.09)	51.8(2.04)	-	-	-	47.8(1.88)	-	17.5(0.69)	-	88.9(3.50)	26.2(1-1/32)	123(4.85)	-	-
	SW8P-	1/2 PSW			79.2(3.12)	39.6(1.56)	33.3(1.31)	39.6(1.56)	50.8(2.00)	47.8(1.88)	50.8(2.00)	15.7(0.69)	17.5(0.69)	88.9(3.50)	26.2(1-1/32)	123(4.85)	126(4.97)	9.5(0.37)
	SW8T-	1/2 TSW			79.2(3.12)	39.6(1.56)	33.3(1.31)	42.9(1.69)	50.8(2.00)	46.2(1.82)	47.8(1.88)	15.7(0.62)	17.5(0.69)	88.9(3.50)	26.2(1-1/32)	121(4.78)	123(4.85)	9.5(0.37)
SW12T-	3/4 TSW	79.2(3.12)	39.6(1.56)	-	-	-	46.2(1.82)	-	15.7(0.62)	-	88.9(3.50)	26.2(1-1/32)	121(4.78)	-	11.2(0.44)			

All dimensions shown are for reference only and are subject to change. Dimensions with DK-Lok nuts are in finger-tight position.

- Non-rotating globe disc providing repetitive leak tight shut-off is standard.
- To order Angle Pattern, insert -A in the basic ordering number. Refer to the ordering information on page 3.

**Pressure-Temperature Ratings**

Ratings are based on valves with optional Grafoil packing.

ASME Class	2500		N/A
Material Group	2.2	3.4	N/A
Material Name	SS316	Alloy 400	Alloy C-276
Temperature, °F (°C)	Working pressure, psig (bar)		
-65 (-53) to 100 (38)	6000 (413)	5000 (344)	6000 (413)
200 (93)	5160 (355)	4400 (303)	6000 (413)
300 (148)	4660 (321)	4120 (283)	6000 (413)
400 (204)	4280 (294)	3980 (274)	5880 (405)
500 (260)	3980 (274)	3960 (272)	5540 (381)
600 (315)	3760 (259)	-	5040 (347)
700 (371)	3600 (248)	-	4730 (325)
800 (426)	3460 (238)	-	4230 (291)
900 (482)	3280 (225)	-	3745 (258)
1000 (537)	3030 (208)	-	3030 (208)
1100 (593)	2685 (184)	-	2685 (184)
1200 (648)	1715 (118)	-	1545 (106)

**Grafoil packing information**

Grafoil is a high temperature packing material that requires a load on the material to generate a seal. In air, Grafoil maximum temperature is 973°F (523°C), in steam, Grafoil goes up to the maximum temperature of 1,200°F (648°C). Grafoil packing is not for use with pneumatic actuating valves.

**Valve ratings with DK-Lok end connections**

Valve ratings may be limited to the maximum working pressure of connective pipe and tubing. For valve rating with DK-Lok tube fitting end connections, refer to DK-Lok catalog providing suggested working pressures in various tubing OD, wall thicknesses, and materials.

**Packing adjustment and actuation torque**

Extreme temperature fluctuations while valve in service may require packing adjustment. Valves that have not been actuated for a period of time may have a higher initial actuation torque.

**Valve ratings with optional PEEK packing** SS316 and C276 valve with PEEK packing is limited to maximum 600 °F (315 °C) rating ; Alloy 400 valve with PEEK packing is limited to maximum 500 °F (260 °C) rating.

**Flow Data @ 100°F (38°C) for valves with regulating disc**

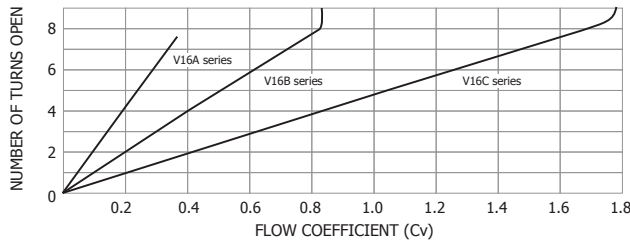

**Globe and Ball Disc**

Valve with standard globe and ball disc is designed for use in a fully open or fully closed position. Refer to Cv in the ordering information and dimensions table on Page 2.

**Cv reduction**

Valve flow may be reduced by the restriction of pipe and tubing connected.



**Sour Gas Valves**

Valves for use in sour gas are available. Valve wetted components are selected to the requirements of NACE MR0175 for sulfide stress cracking resistant materials. To order, insert -SG in the basic ordering number.

**Optional Handles**

SS316 bar handle is standard. Optional anodized black aluminum bar handle is available. To order valve with factory-assembled optional aluminum handle, insert designator -AH in the ordering number. To order handle for field assembly, select desired handle ordering number from the table.

Valve Series	Field Assembly Bar Handle	
	SS316	Aluminum
V16A	V16A-BH	V16A-AH
V16B	V16B-BH	V16B-AH
V16C	V16C-BH	V16C-AH

**Ordering Information**

Select the desired valve basic ordering number, options and body material.

V16B-D-6T- V16C-MF-12N-	A	-PK GF	-B	-AH	-SG	-BD	-S
Valve Pattern Designator	Packing Material Designator	Stem Disc Designator	Handle Designator	Sour Gas Designator	Pneumatic Double Acting Actuator	Valve Material Designator	
Nil : In-line A : Angle	Nil : PTFE PK : PEEK GF : Grafoil*	Nil : Globe R : Regulating B : Ball	Nil : SS316 bar handle AH : Aluminum Bar handle	Nil : no Sour Gas SG : Sour Gas	AD : V16A series valves BD : V16B series valves	S : SS316 M : Alloy 400 HC : Alloy C276	

\* Grafoil™ UCAR

We reserve the right to change the specifications stated in this catalog for our continuing program of improvement.

**Double Acting Pneumatic Actuator**

V16 series Pneumatic actuators are designed to actuate valves remotely. V16A and V16B series are available to be equipped with pneumatic actuators in double acting.

**Double Acting Dimensions**

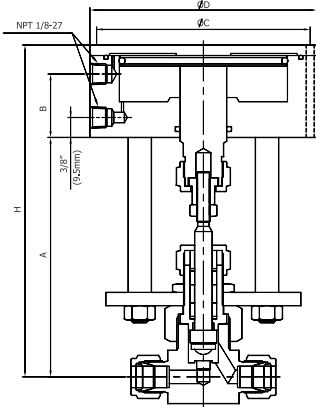

Valve Series	Dimensions in. (mm)				
	A	H	D	C	B
V16A	4.22 (107)	5.91 (150)	3.25 (82.6)	3.25 (82.6)	1.12 (28.4)
V16B	4.47 (114)	6.22 (158)	4.25 (108)	3.81 (96.8)	1.19 (30.2)

All dimensions are reference only and subject to change.

**Double Acting Actuator Technical Data**

Maximum applicable pressure	Temperature ratings °F (°C)
150 psig (10.4 bar)	-20 to 300 (-28 to 204)

**Pneumatic Actuator Applicability**

V16A and V16B series valves with PTFE or PEEK packing are applicable to pneumatic actuator. Those valves with Grafoil packing are not applicable to pneumatic actuator.

**Operation Information**

Curve 1 and 2 indicate the minimum actuator pressure to open or close double acting actuator against system pressure. To prolong valve life, actuators should be operated at minimum air actuator pressures.

Curves shown are based on packing bolt factory adjustment.

Packing bolt adjustment may be required to maintain the valve leak-tight.

If the packing bolt is over-tightened, the actuating pressure can not overcome the friction force between the over-tightened packing and the stem. If the packing bolt is under-tightened for low system pressures, it may leak at high system pressures.

However, packing bolt torque must be sufficiently maintained to prevent packing from leakage.

**Curve 1**

V16A series with Double Acting Actuator -AD

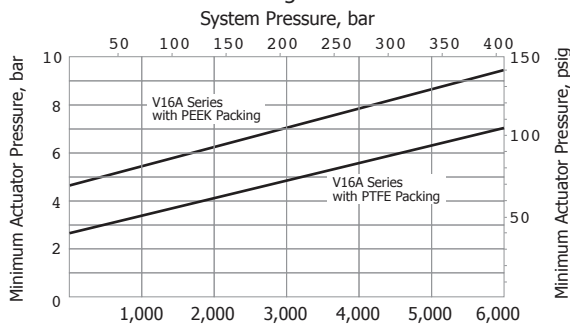

**Curve 1**

V16B series with Double Acting Actuator -BD

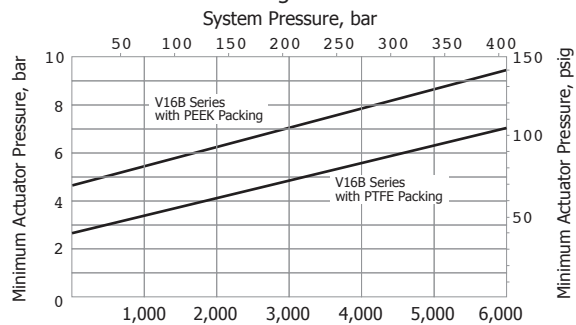

**Actuator Ordering Information**

To order valves with a pneumatic double acting actuator, insert the desired actuator designator from the chart in the valve ordering number.

Example: V16B-D6T-PK-B-**BD**-S

Valve Series	Double Acting Designator
V16A	AD
V16B	BD

**Safe Valve Selection**

The selection of a valve for any application or system design must be considered to ensure safe performance.

Valve function, valve rating, material compatibility, proper installation, operation and maintenance remain the sole responsibility of the system designer and the user. DK-Lok accepts no liability for any improper selection, installation, operation or maintenance.